

3003009 (Oak/Black)

RH LEVA DESK

Weight Limit
50.7 lbs / 23 kg

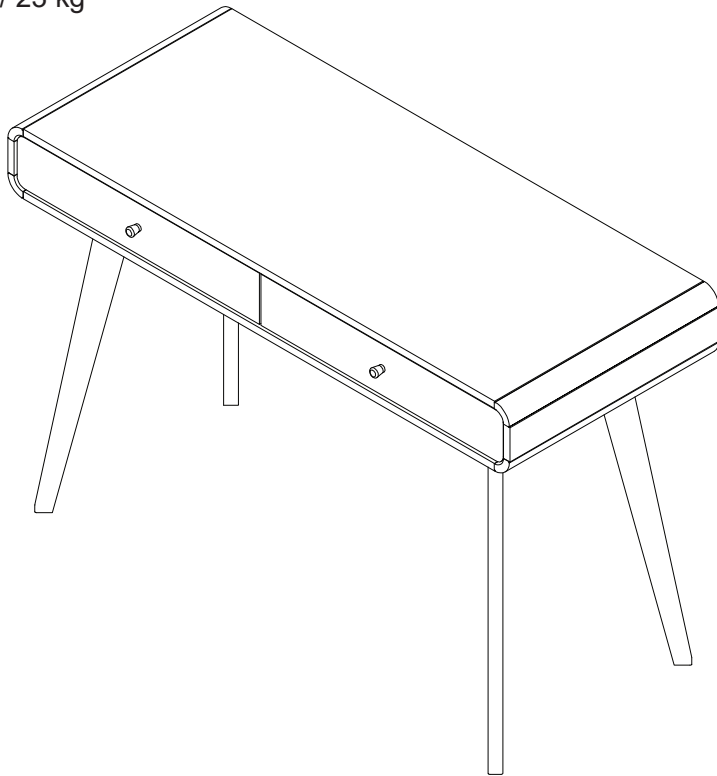

Thank you for purchasing from RealRooms!

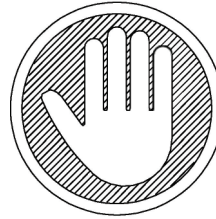

**Questions, concerns, missing parts?
CONTACT OUR CUSTOMER SERVICE DEPARTMENT
BEFORE RETURNING PRODUCT TO THE RETAILER.**

If parts are missing or damaged, we will gladly ship your replacement parts free of charge.

Visit www.realrooms.com
or call Toll-Free **1-888-489-0077**

Date of Purchase

Lot Number (TAKEN FROM CARTON)



**THIS INSTRUCTION BOOKLET CONTAINS IMPORTANT SAFETY
INFORMATION. PLEASE READ AND KEEP FOR FUTURE REFERENCE.**

Limited 1 year Warranty

RealRooms warrants this product to be free from defects in material and workmanship and agrees to remedy any such defect. This warranty covers one year from the date of original purchase from authorized retailers. This is solely limited to the repair or replacement of defective parts and assembly labor is not included.

This warranty does not apply to any product which has been improperly assembled, subjected to misuse or abuse or which has been altered or repaired in any way. The warranty does not cover wearing, tearing, fading or splitting of the fabric (where applicable). Liability for consequential damages is excluded to the extent exclusion is permitted by law. This warranty gives you specific legal rights and you may also have other rights which vary from state to state or province to province.

To obtain warranty service, purchaser must present original bill of sale. Components repaired or replaced are warranted through the remainder of the original warranty period only. The defective components will be repaired or replaced without charge, subject to the terms and conditions described above.

The terms and conditions of the limited warranty are subject to change without notice.

Contact Us!

For help with assembly, identifying parts, product information or to order parts, please contact us:



cs@realrooms.com



1-888-489-0077

Read Before Beginning Assembly

- Work in a spacious area and near where the unit will be used, preferably on a carpet, or use a piece of the cardboard packaging to protect your floor and product.
- Make sure all parts are included. Most parts are labeled or stamped on the raw edge.
- Read each step carefully. It is very important that each step of the instructions is performed in the correct order. If these steps are not followed in sequence, assembly difficulties will occur.
- This product may contain small components. Please ensure that they are kept away from small children.
- This product is designed for home use and is not intended for commercial use.

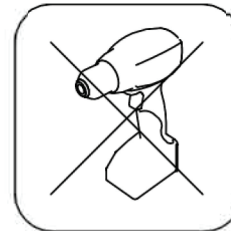
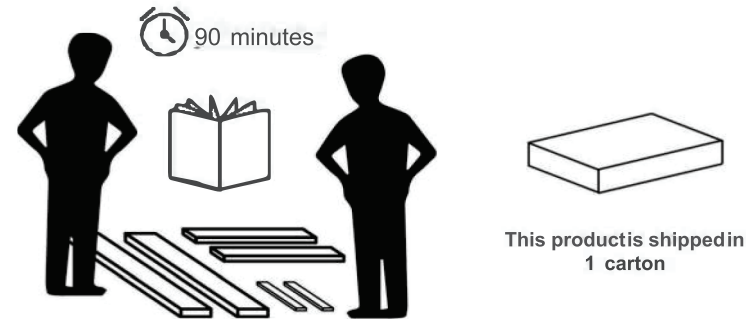

Do NOT use
power tools

Tools required to complete assembly (not included)



Flat head screwdriver



Phillips head screwdriver

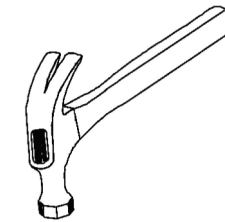

Hammer



Mallet

PARTS

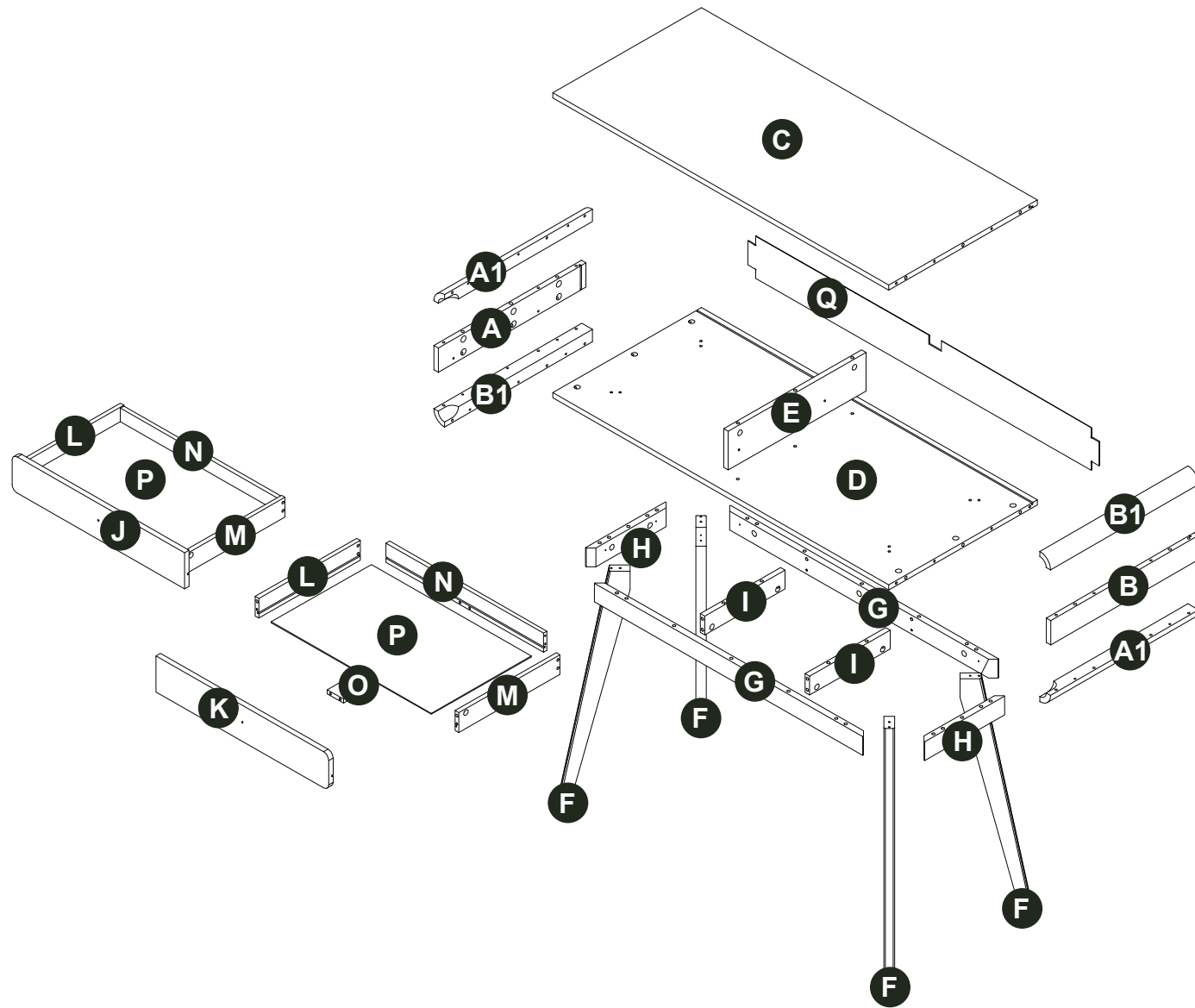

PARTS LIST

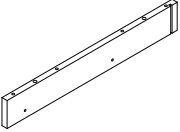
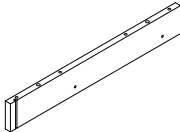
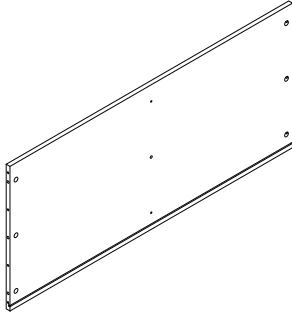
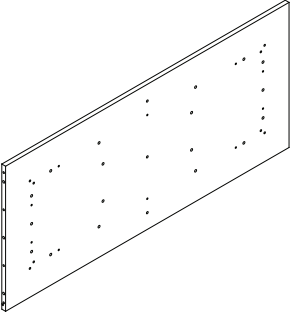
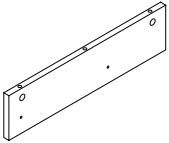
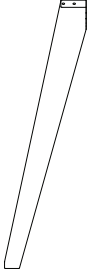
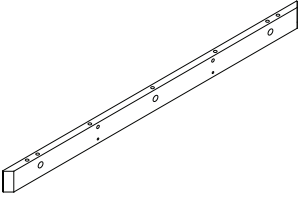
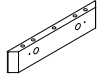
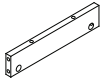
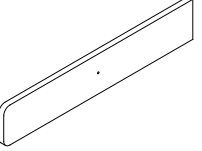
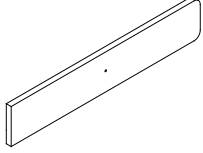
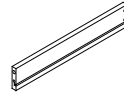
<p>A</p> 	<p>B</p> 	<p>C</p> 	<p>D</p> 
<p>SIDE PANEL LEFT 1 PC</p>	<p>SIDE PANEL RIGHT 1 PC</p>	<p>TOP PANEL 1 PC</p>	<p>BOTTOM PANEL 1 PC</p>
<p>E</p> 	<p>F</p> 	<p>G</p> 	<p>H</p> 
<p>CENTER PANEL 1 PC</p>	<p>LEG PANEL 4 PC</p>	<p>LEG FRAME PANEL 2 PC</p>	<p>LEG FRAME SIDE PANEL 2 PC</p>
<p>I</p> 	<p>J</p> 	<p>K</p> 	<p>L</p> 
<p>LEG FRAME CENTER PANEL 2 PC</p>	<p>DRAWER FRONT RIGHT 1 PC</p>	<p>DRAWER FRONT LEFT 1 PC</p>	<p>DRAWER SIDE LEFT 2 PC</p>

PARTS LIST

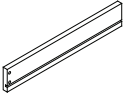
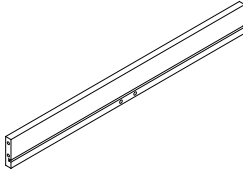
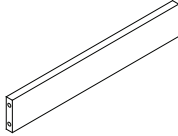
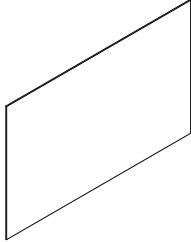
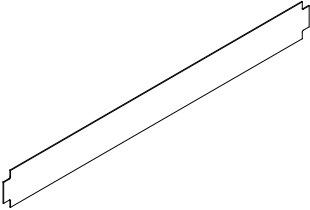
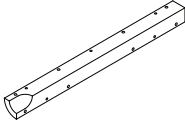
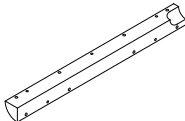
			
<p>DRAWER SIDE RIGHT 2 PC</p>	<p>DRAWER BACK 2 PC</p>	<p>DRAWER SUPPORT 2 PC</p>	<p>DRAWER BOTTOM PANEL 2 PC</p>
			
<p>BACKPLY PANEL 1 PC</p>	<p>SIDE PROFILE PANEL 2 PC</p>	<p>SIDE PROFILE PANEL 2 PC</p>	







PART NUMBERS

PART LABELS	3003009 (Oak/Black)	PART LABELS	3003009 (Oak/Black)
A	U5671611-A	K	U5671611-K
B	U5671611-B	L	U5671611-L
C	U5671611-C	M	U5671611-M
D	U5671611-D	N	U5671611-N
E	U5671611-E	O	U5671611-O
F	U5671611-F	P	U5671611-P
G	U5671611-G	Q	U5671611-Q
H	U5671611-H	A1	U5671611-A1
I	U5671611-I	B1	U5671611-B1
J	U5671611-J		

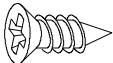
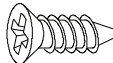
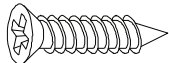
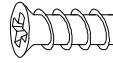
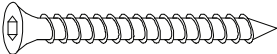

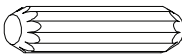
 Each part has a unique part number. Please reference the appropriate part number when contacting customer service for replacement parts.

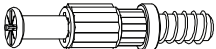
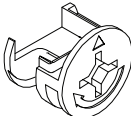
 Before throwing any packaging, please verify all contents and make sure you have received all the parts listed above!

HARDWARE LIST

<p>①</p> 	<p>②</p> 	<p>③</p> 	<p>④</p> 
<p>3.5mm x 12mm SCREW 8 PC</p>	<p>3.5mm x 15mm SCREW 8 PC</p>	<p>4mm x 25mm SCREW 8 PC</p>	<p>6mm x 13mm SCREW 8 PC</p>
<p>⑤</p> 	<p>⑥</p> 	<p>⑦</p> 	<p>⑧</p> 
<p>6mm x 40mm SCREW 19 PC</p>	<p>6mm x 20mm WOOD DOWEL 12 PC</p>	<p>6mm x 35mm WOOD DOWEL 32 PC</p>	<p>8mm x 25mm WOOD DOWEL 23 PC</p>
<p>⑨</p> 	<p>⑩</p> 	<p>⑪</p> 	<p>⑫</p> 
<p>20mm x 5mm MINIFIX 44 PC</p>	<p>12mm x 15mm CAM 40 PC</p>	<p>9mm x 15mm CAM 4 PC</p>	<p>4mm x 25mm SCREW 2 PC</p>

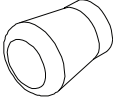
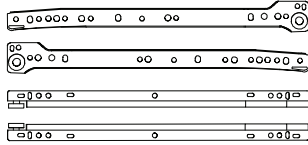
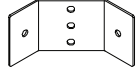
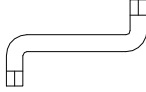
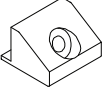
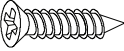
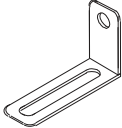
HARDWARE LIST

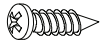
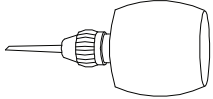
<p>⑬</p> 	<p>⑭</p> 	<p>⑮</p> 	<p>⑯</p> 
<p>WOODEN KNOB HANDLE 2 PC</p>	<p>350 mm DRAWER SLIDE 2 SET</p>	<p>TABLE CORNER BRACKET 5 HOLE 4 PC</p>	<p>ALLEN KEY M4 1 PC</p>
<p>⑰</p> 	<p>⑱</p> 	<p>⑲</p> 	<p>⑳</p> 
<p>BACKPLY STOPPER 12 PC</p>	<p>3.1mm x 20mm SCREW 12 PC</p>	<p>L-MOUNTING BRACKET 1 PC</p>	<p>4mm x 52mm SCREW 1 PC</p>
<p>㉑</p> 	<p>㉒</p> 	<p>㉓</p> 	
<p>WALL PLUG 25MM 1 PC</p>	<p>4mm x 16mm SCREW 1 PC</p>	<p>GLUE 5 PC</p>	

Hardware Pack

3003009 (Oak/Black)



HP# : TU5671611-01

⚠ Please do not completely tighten all the hardware, until the entire assembly is complete, unless otherwise indicated in the step-by-step instructions.

⚠ The screw(s), bolt(s) to be used at each step are shown in actual size in the lower right corner of the page.

Step 1

For each hole with dowel (6),(7) & (8), place a small drop of glue (23), then process to insert a dowel.

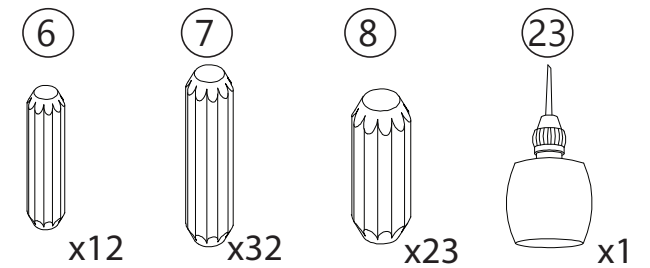
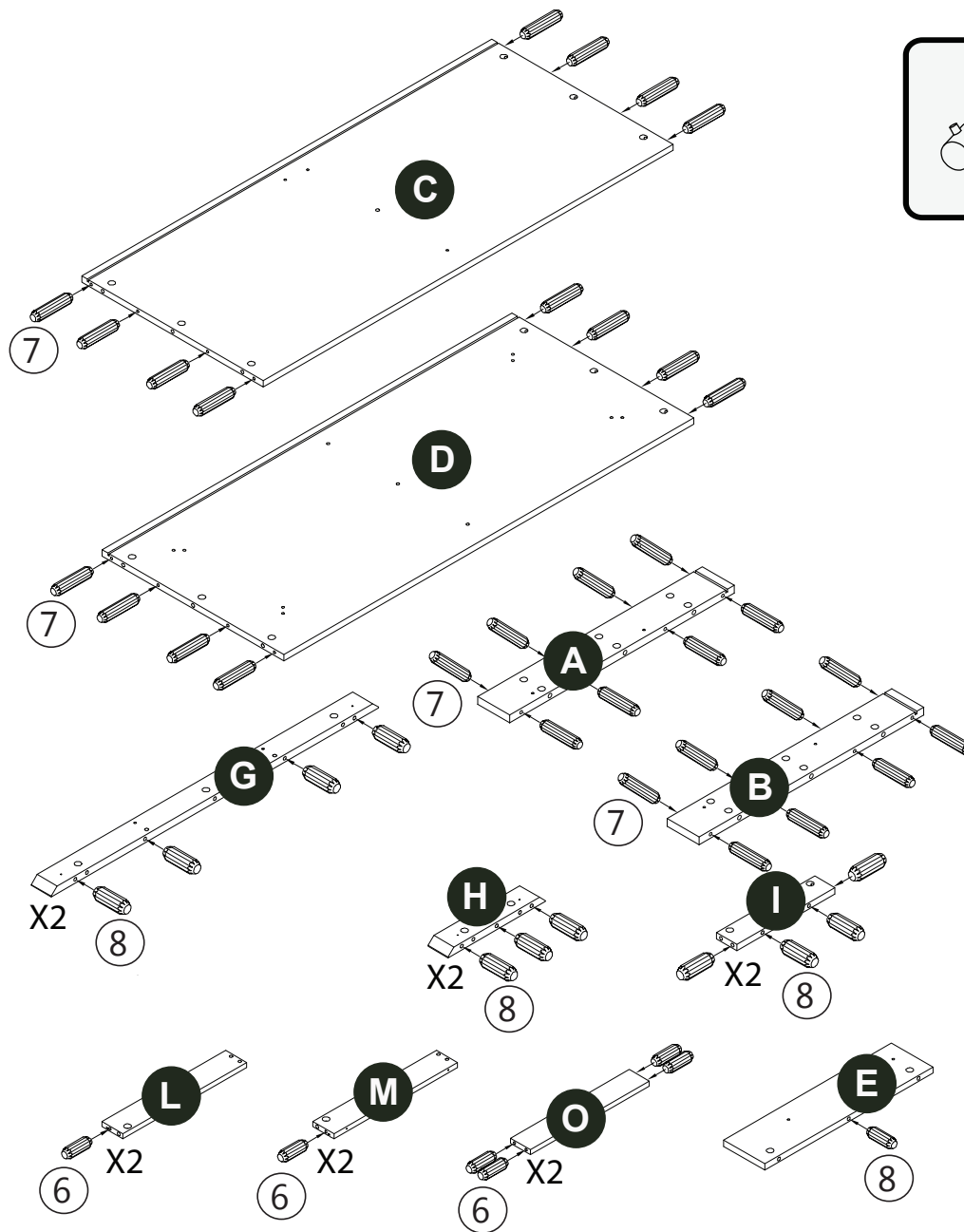
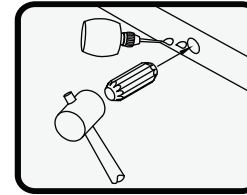

Step 2



Phillips head screwdriver

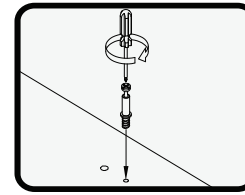
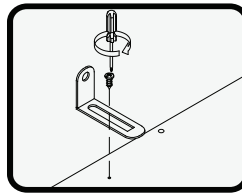

Insert the minifix (9) then tighten it with a screwdriver. Then align the L-mounting bracket (19) then tighten it with screw (22).

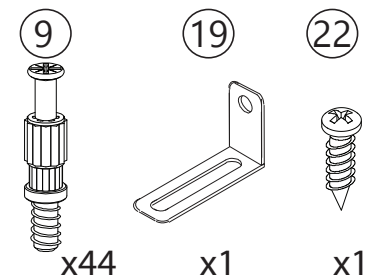
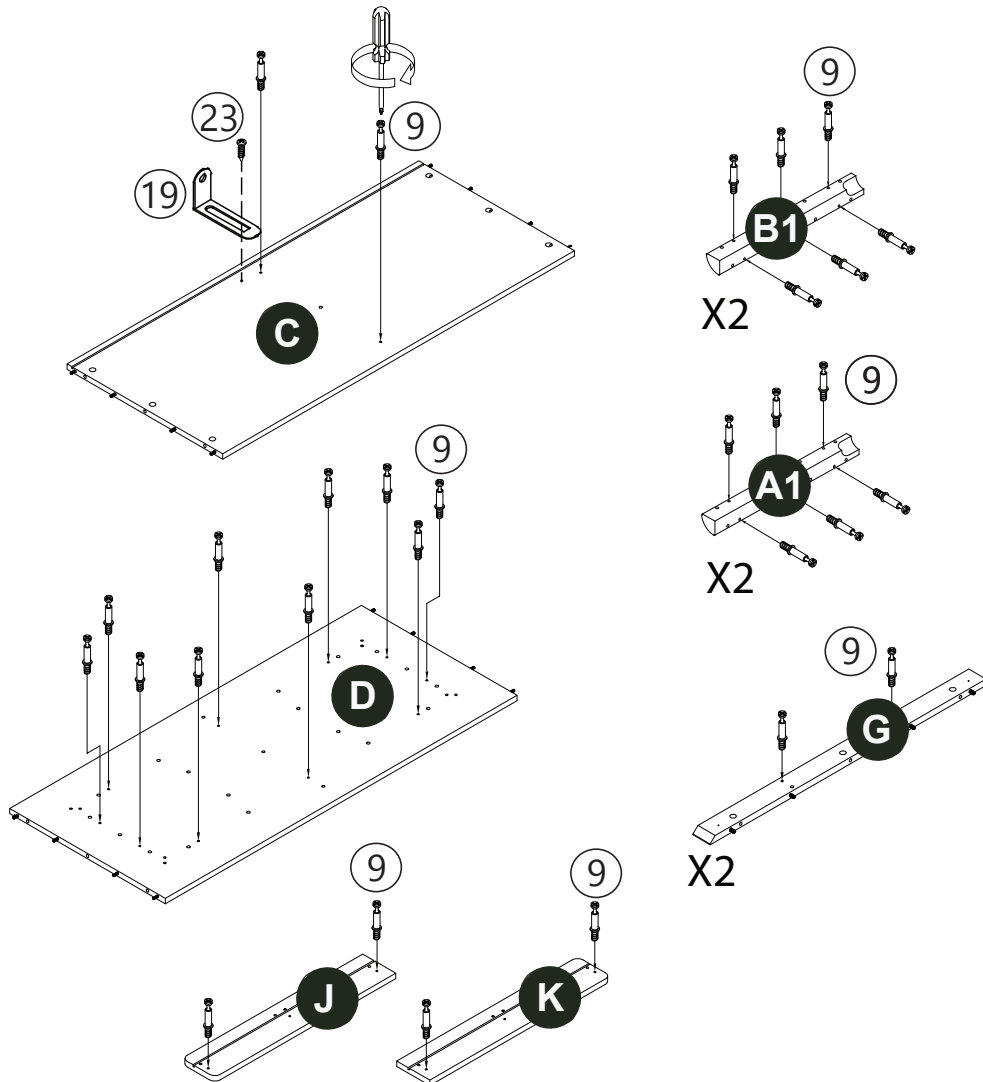

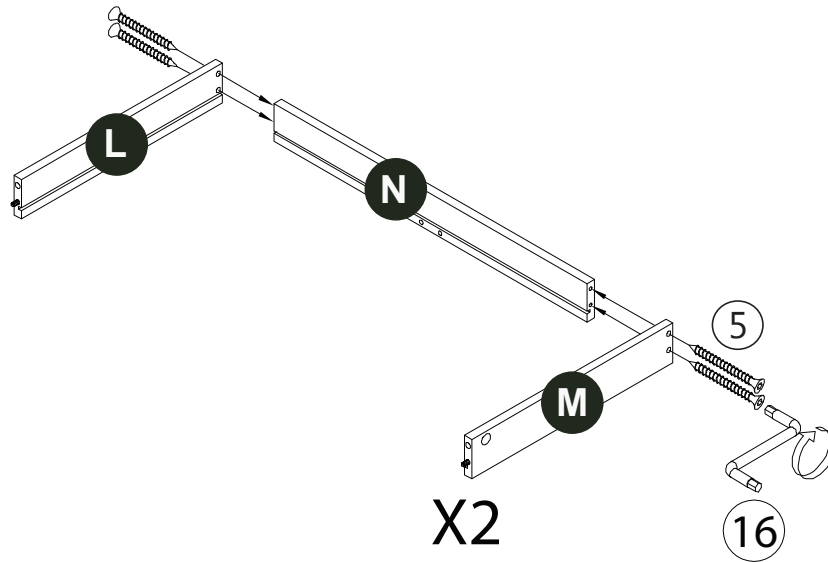
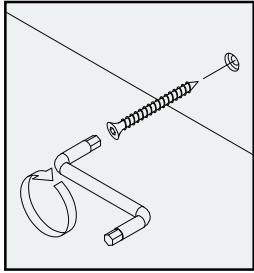

Step 3

Attached drawer side panels **L** & **M** to drawer back **N** and then tighten it with screw (5).

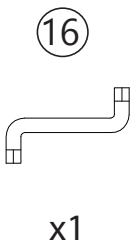
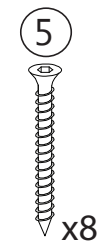

Step 4

Insert drawer bottom **P** between drawer side **L** & **M** then continue with drawer support **O**.

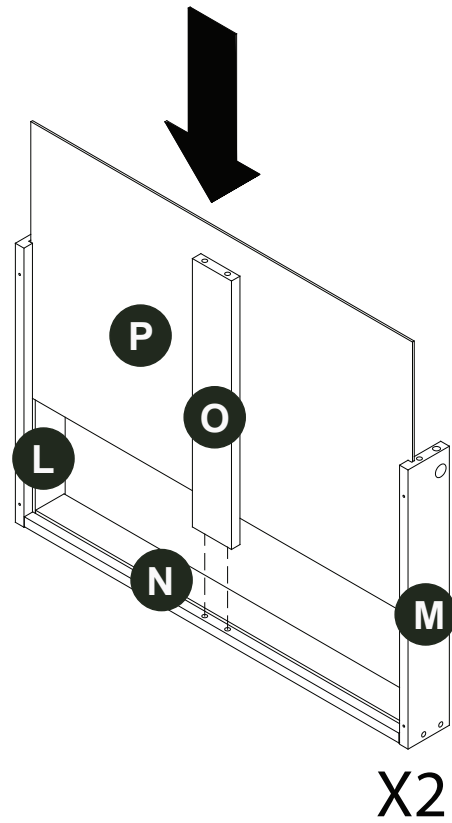

Step 5

Insert cam (11) in each panel and tighten all of it accordingly.

Before attach the other panel place a small drop of glue (23) in wood dowel hole.

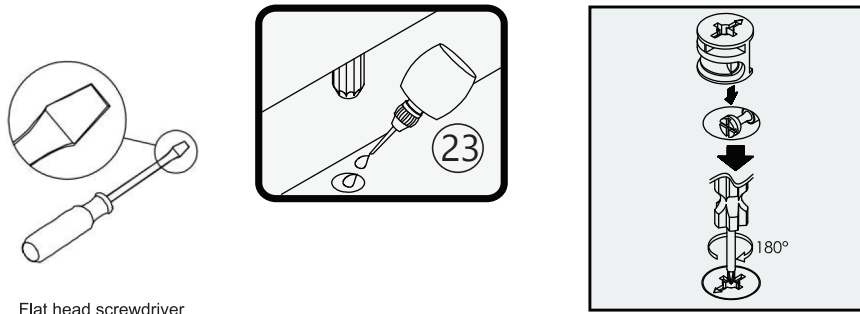

Flat head screwdriver

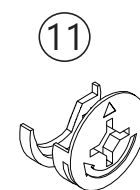
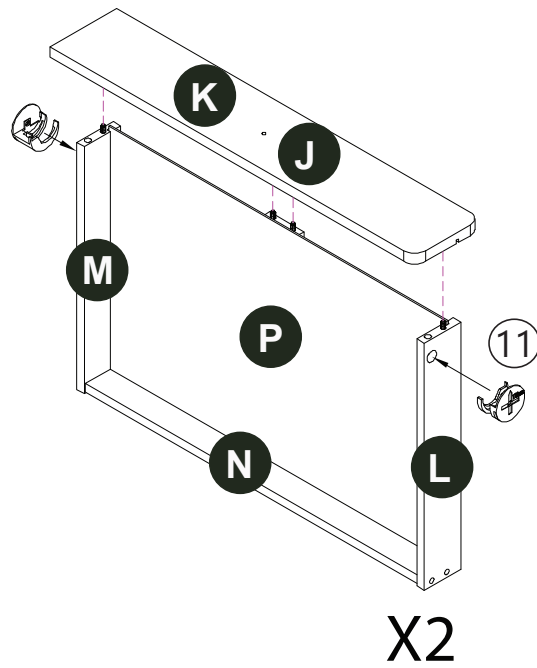

x4

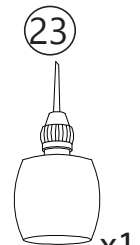

x1

Step 6

Positioning the Drawer slide (14) make sure the drawer slide roller is facing on the drawer back as shown on the left then tighten it with screw (1).

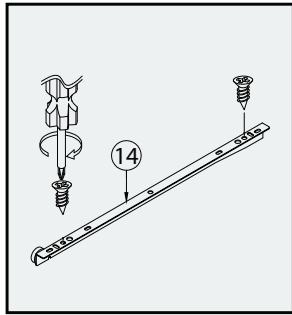

(L)

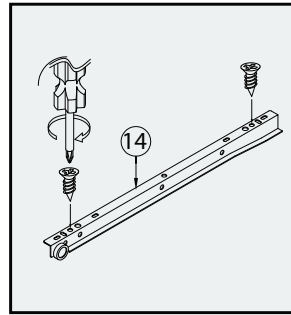

(R)



Phillips head screwdriver

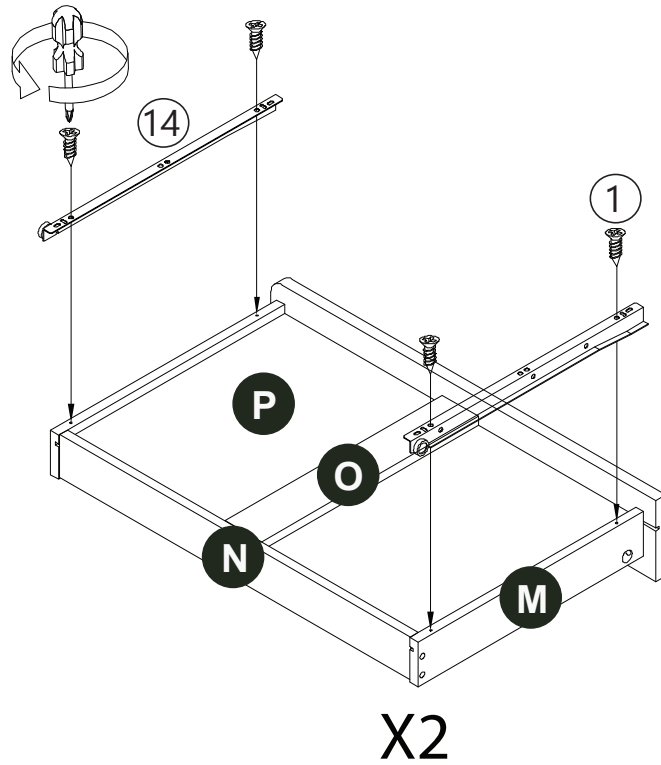

X2

1



x8

14

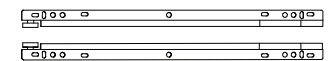

x2

Step 7

Use screw (12) and wooden knob handle (13) then tighten it using a screwdriver.

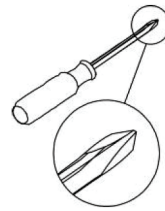

Phillips head screwdriver

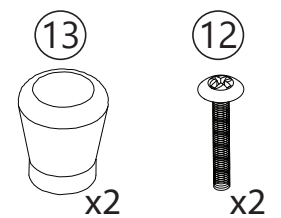
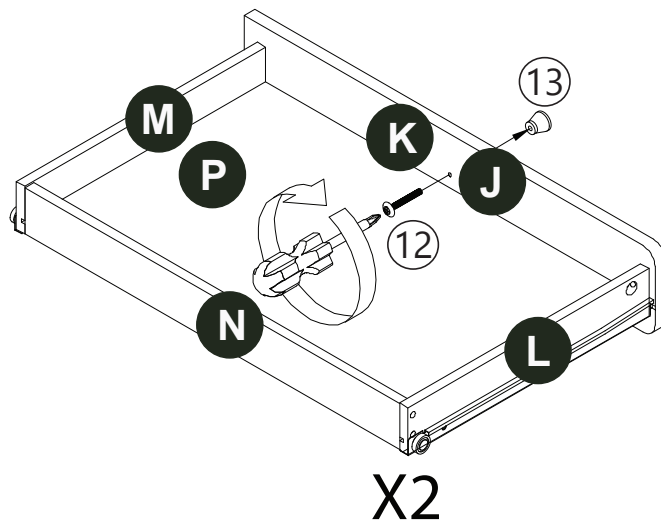

Step 8

Insert cam (10) in each panel and tighten all of it accordingly.

Before attach the other panel place a small drop of glue (23) in wood dowel hole.



Flat head screwdriver

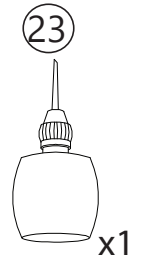
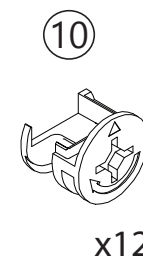
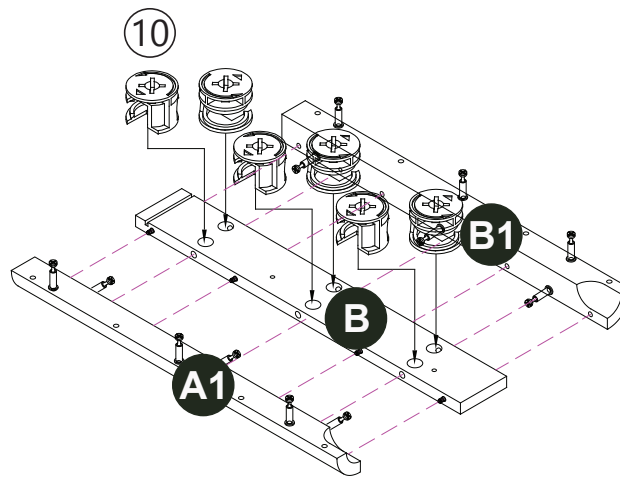
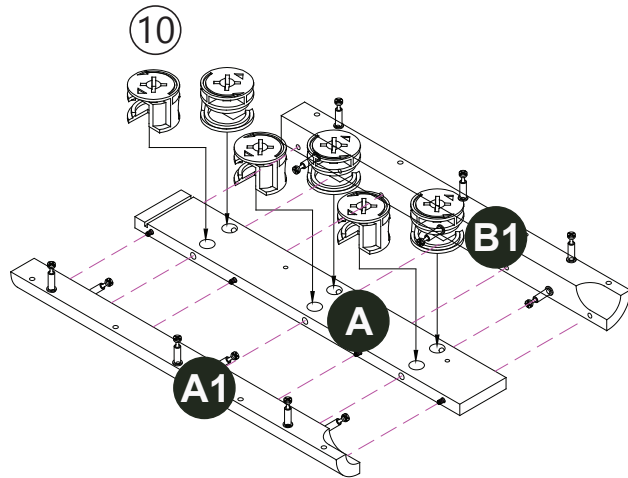
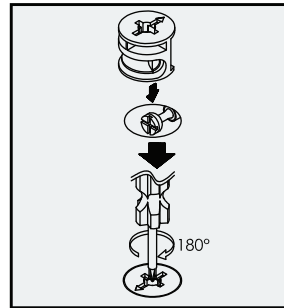
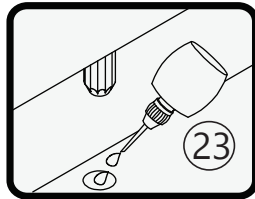

Step 9

Attached the drawer slide (14) and tighten it with screw (4) make sure to position the drawer slide as shown.

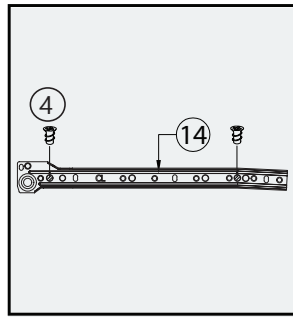

(L)

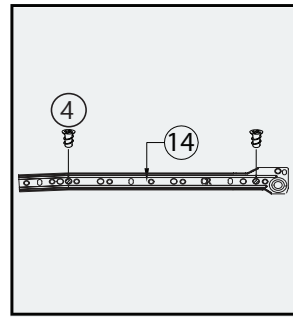

(R)

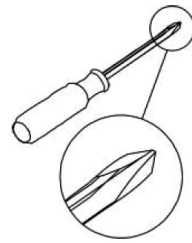

Phillips head screwdriver

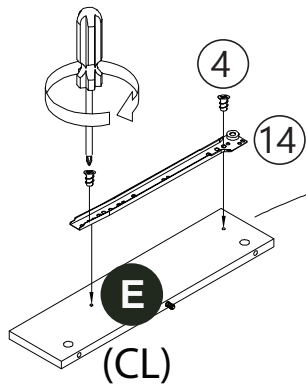

(CL)

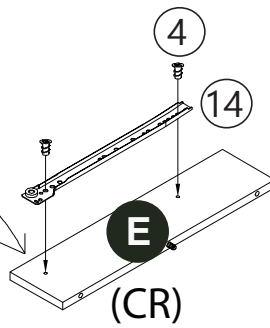

(CR)

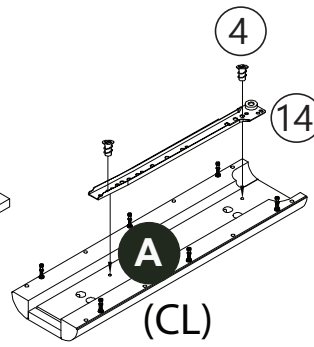

(CL)

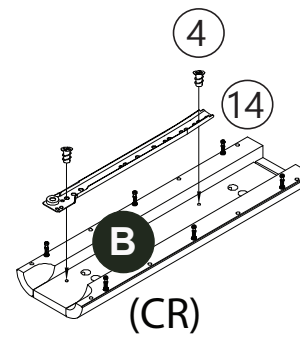

(CR)

4



x8

14

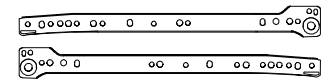

x2

Step 10

Insert cam (10) in each panel and tighten all of it accordingly.

Before attach the other panel place a small drop of glue (23) in wood dowel hole.

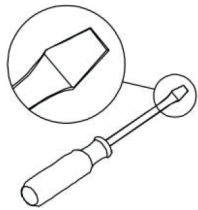

Flat head screwdriver

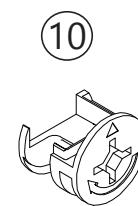
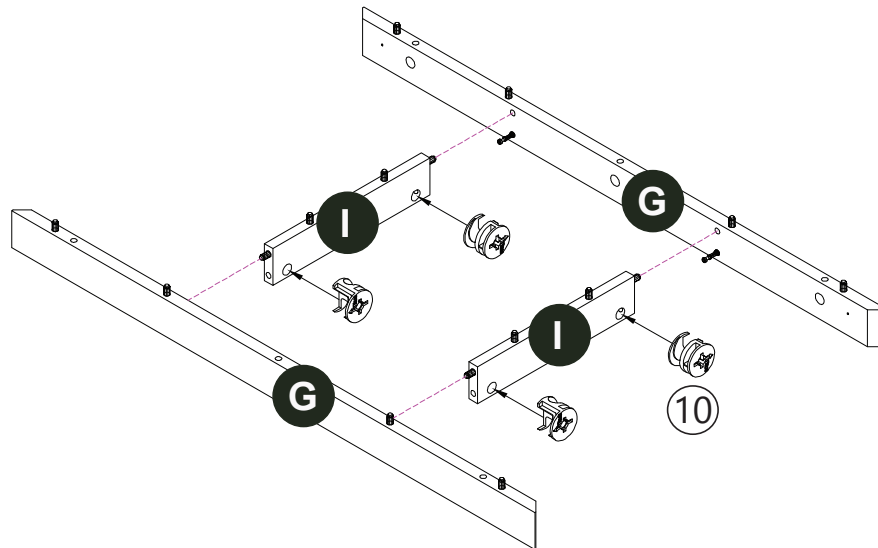
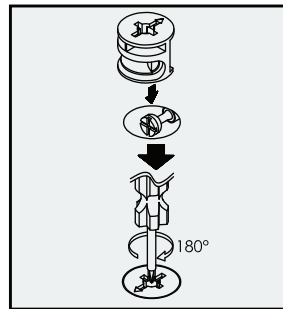
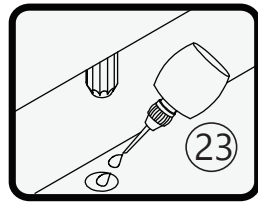

x12

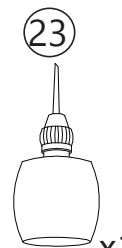

x1

Step 11

Before attach the other panel place a small drop of glue (23) in wood dowel hole.

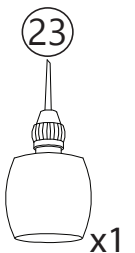
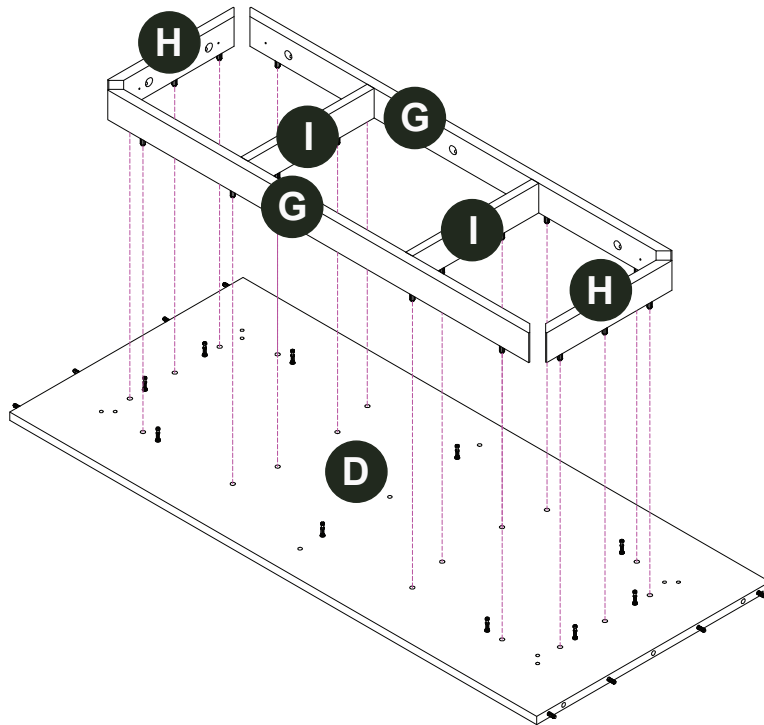
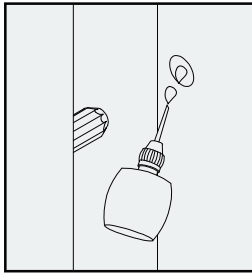

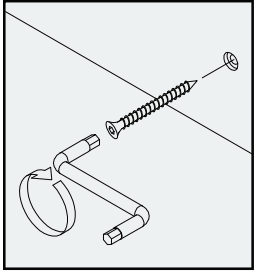

Step 12

Attached the leg **F** to bottom panel **D** and tighten with screw (5).

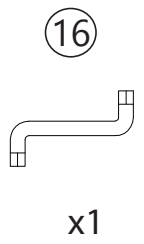
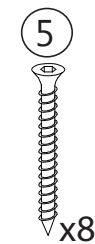
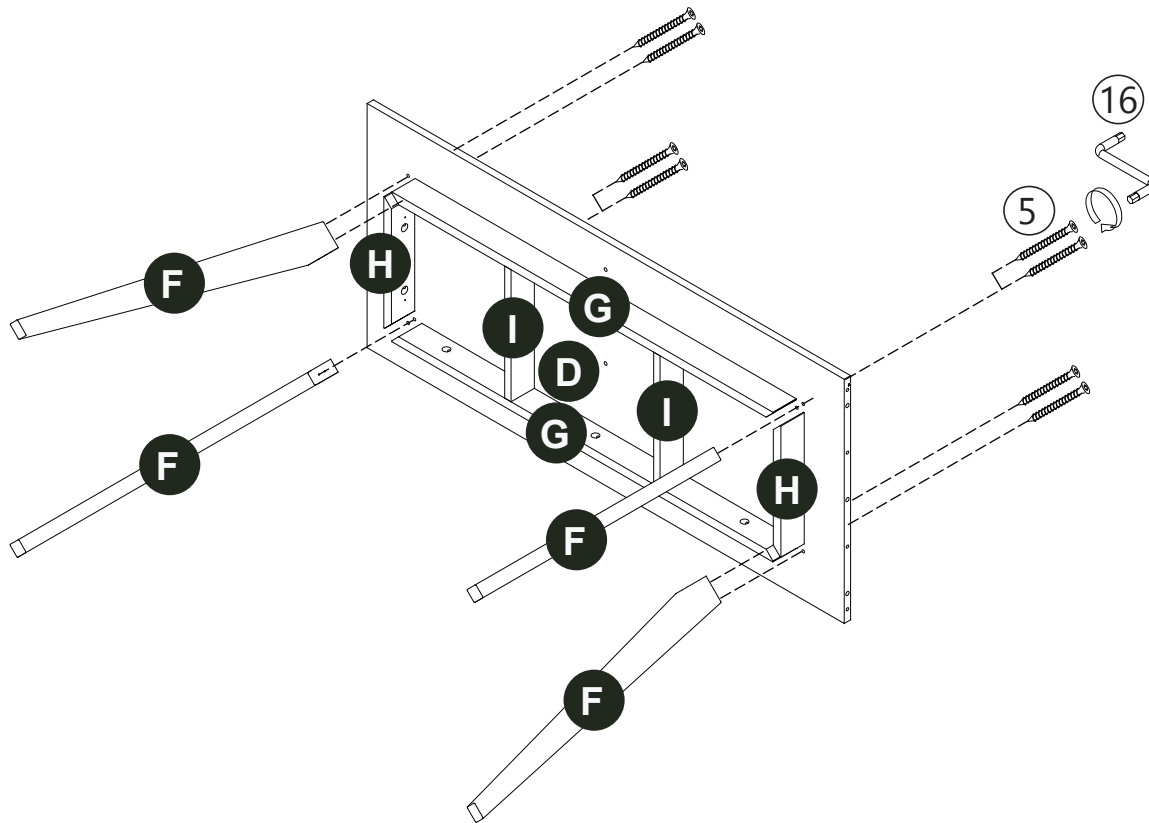

Step 13

Insert cam (10) in each panel and tighten all of it accordingly.

Before attach the other panel place a small drop of glue (23) in wood dowel hole.

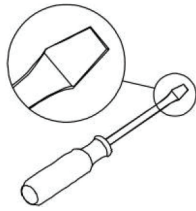

Flat head screwdriver

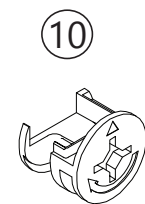
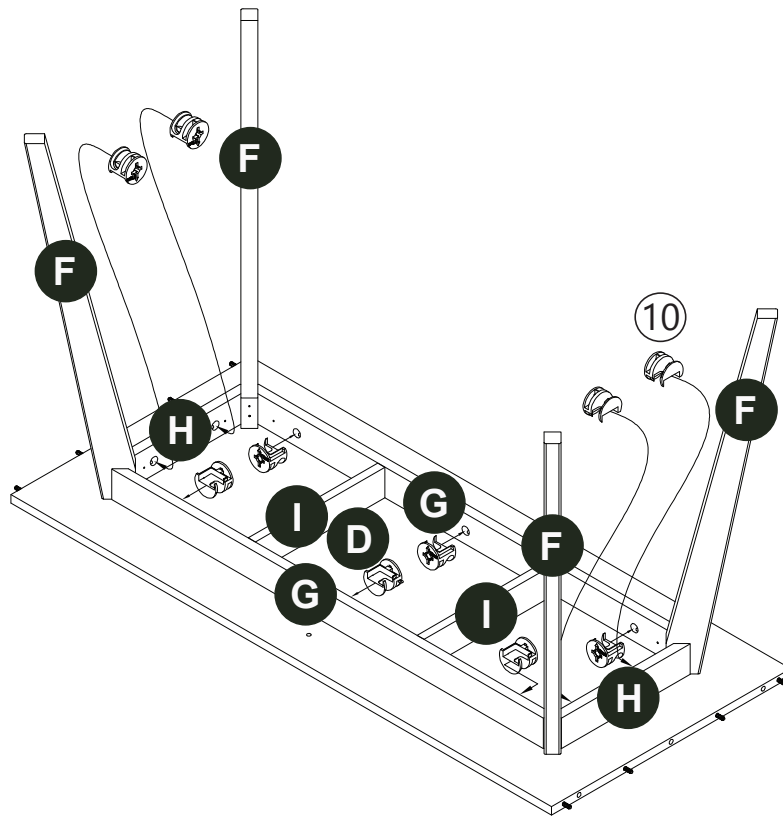
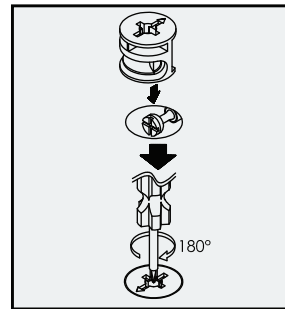
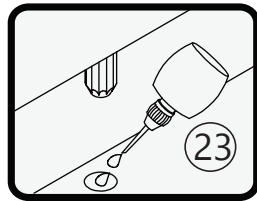

x10

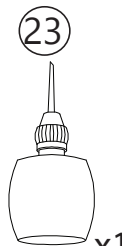

x1

Step 14

Positioning the table corner bracket (15) at the leg frame and tighten the screw (2) & (3) and make sure position the screw according to the step display.

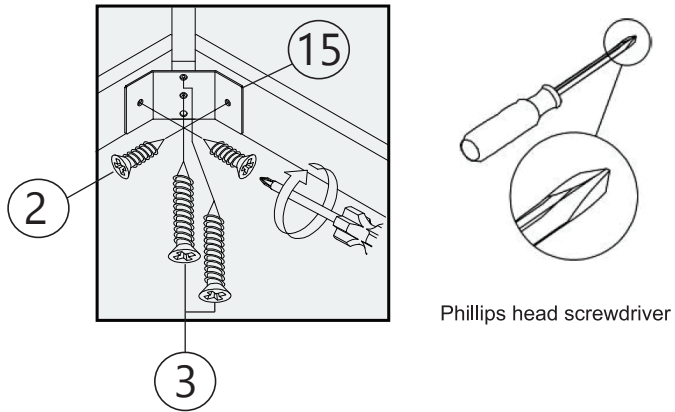

Phillips head screwdriver

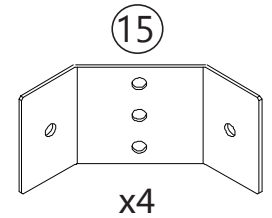
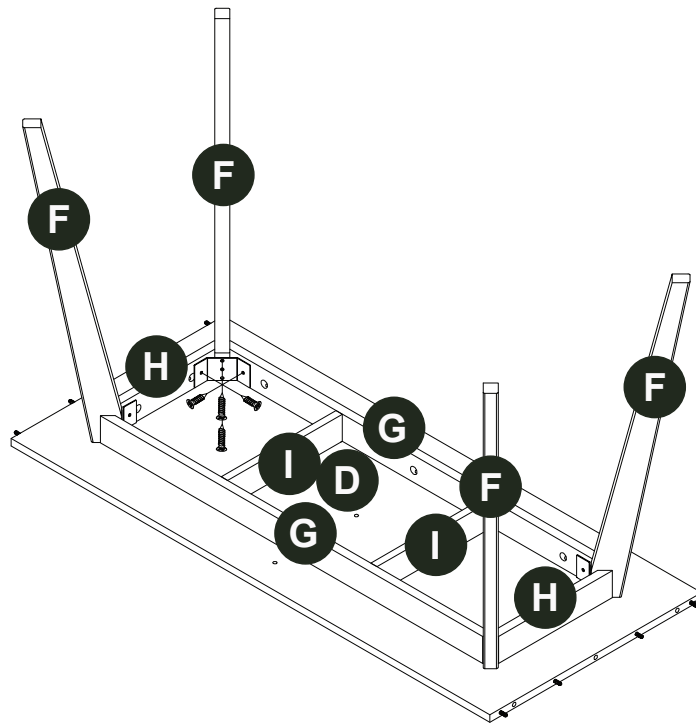

Step 15

Attached center panels **E** and then tighten it with screw (5).

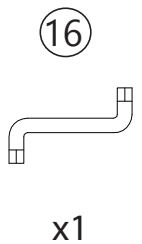
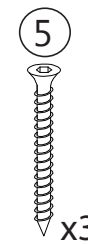
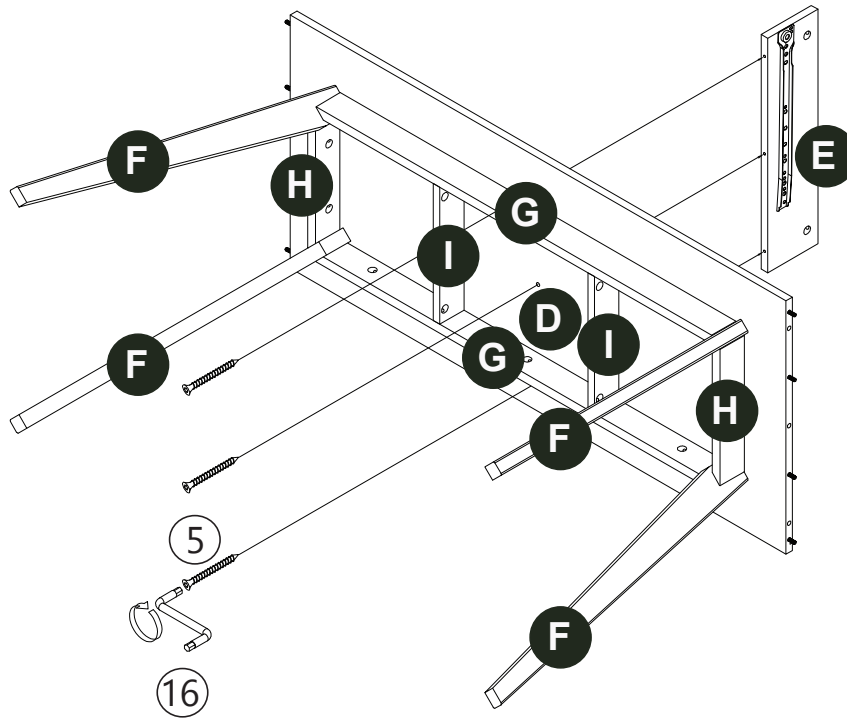
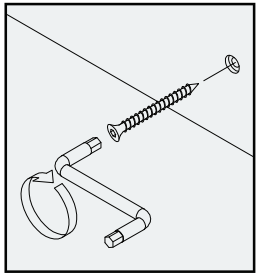

Step 16

Insert the backply **Q** on back of panel **E**.

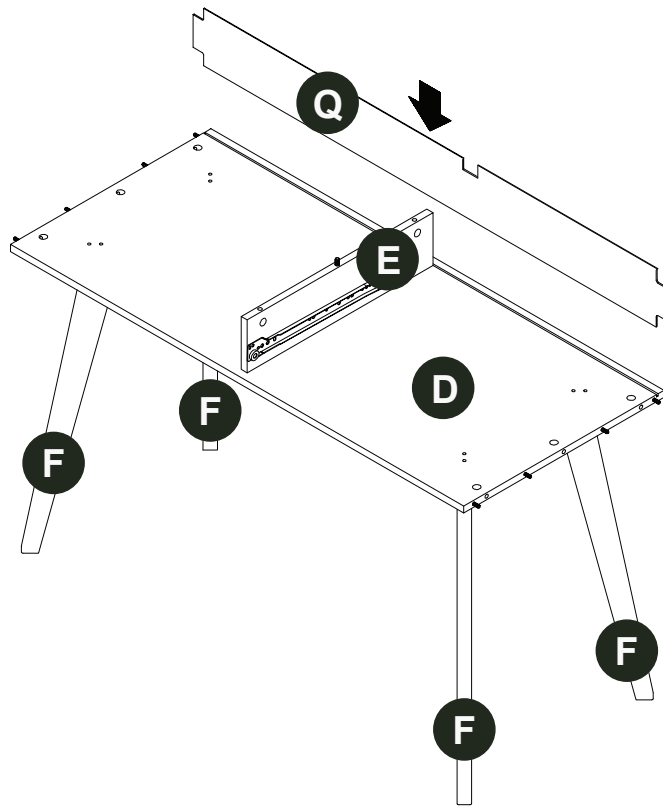

Step 17

Insert cam (10) in each panel and tighten all of it accordingly.

Before attach the other panel place a small drop of glue (23) in wood dowel hole.



Flat head screwdriver

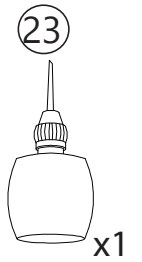
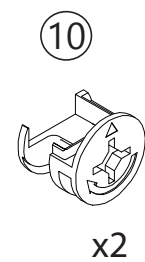
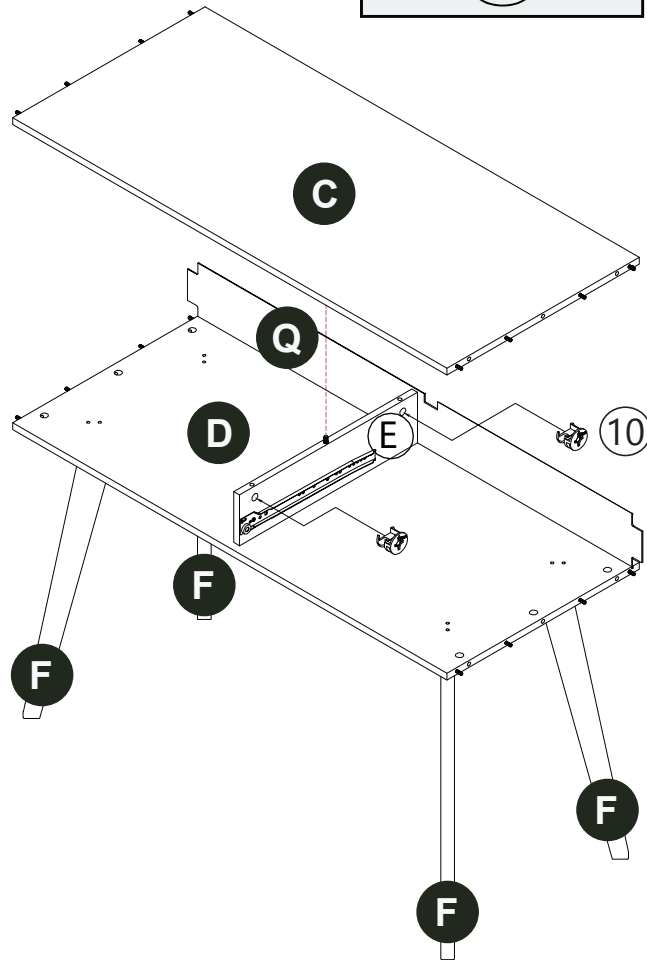
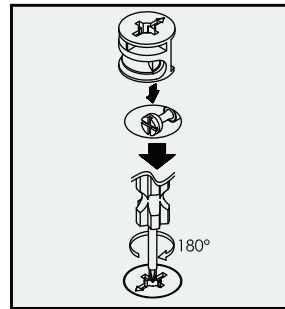
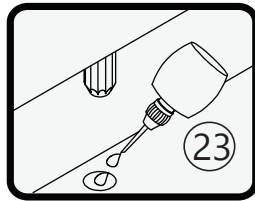

Step 18

Insert cam (10) in each panel and tighten all of it accordingly.

Before attach the other panel place a small drop of glue (23) in wood dowel hole.



Flat head screwdriver

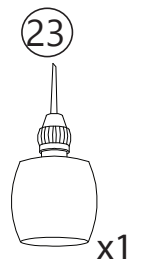
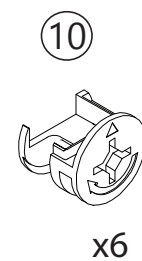
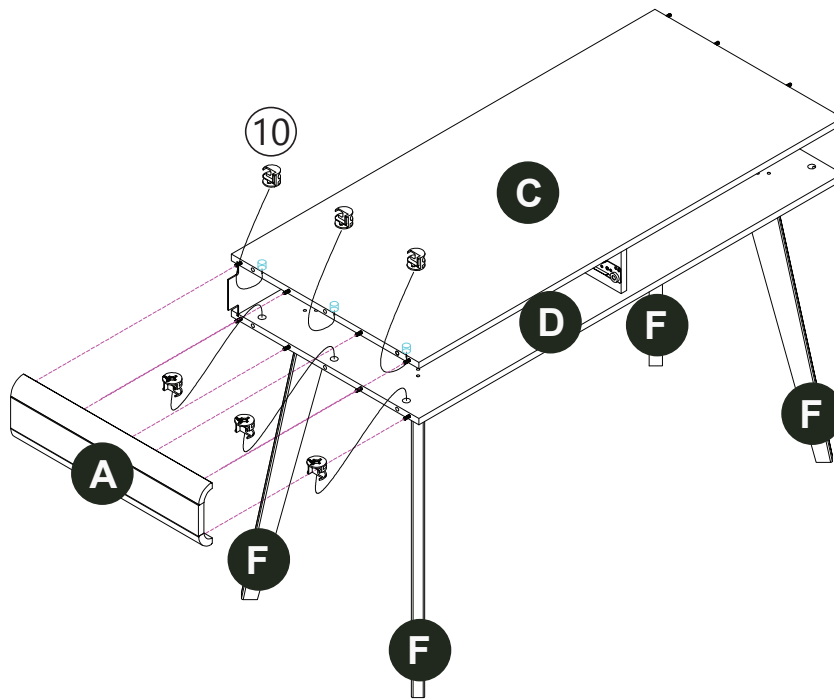
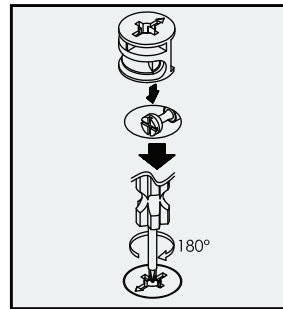
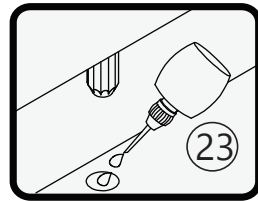

Step 19

Insert cam (10) in each panel and tighten all of it accordingly.

Before attach the other panel place a small drop of glue (23) in wood dowel hole.

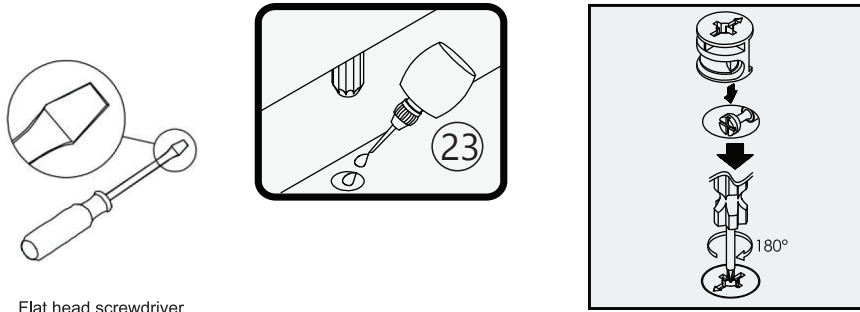

Flat head screwdriver

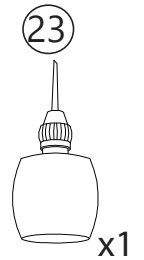
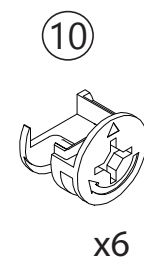
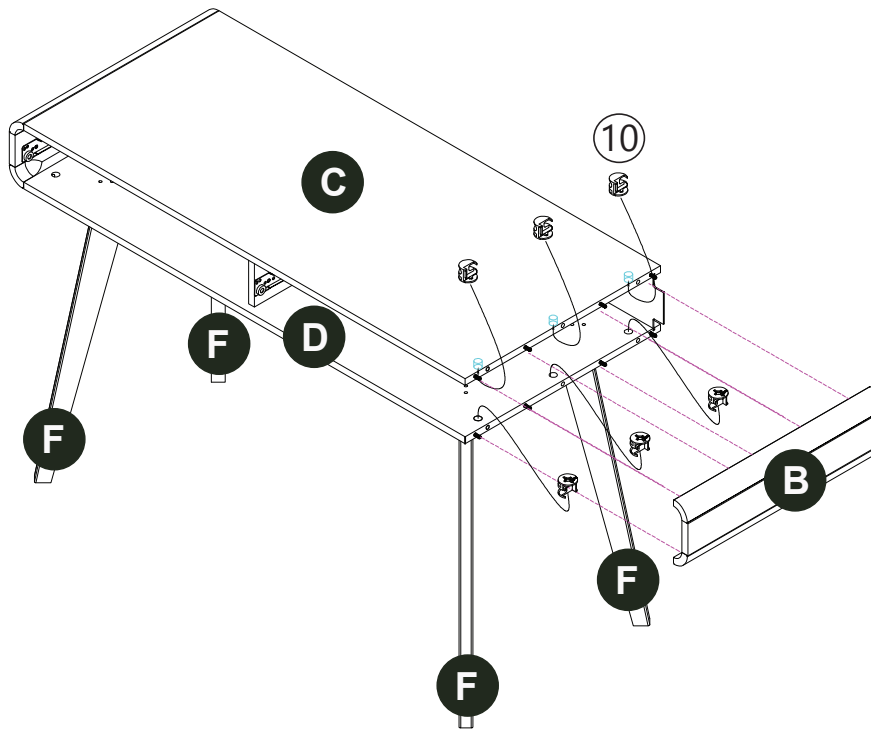

Step 20

Insert backply stopper (17) as shown and use screw (18) to tighten it.

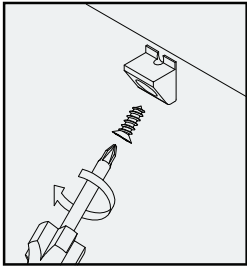

Phillips head screwdriver

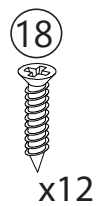
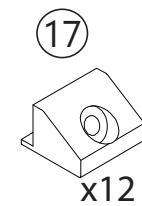
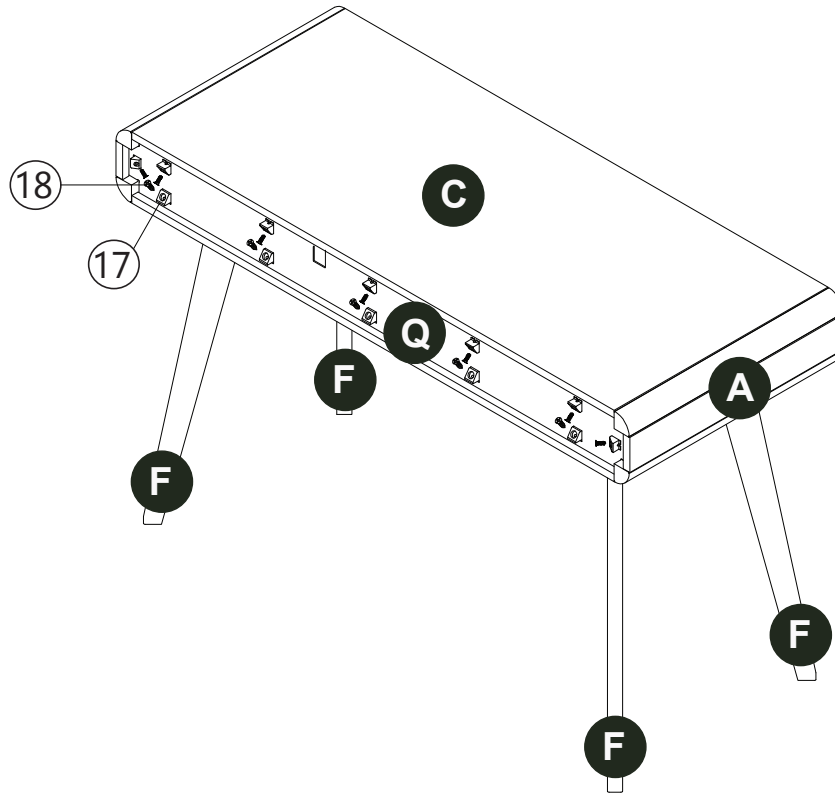

Step 21

Use the L- mounting bracket hole for marking then drill a hole.

Insert the wall plug (21) into the hole then use a hammer, after that use screw (20) to tighten it.

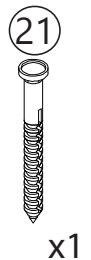
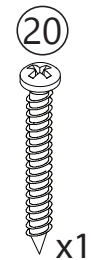
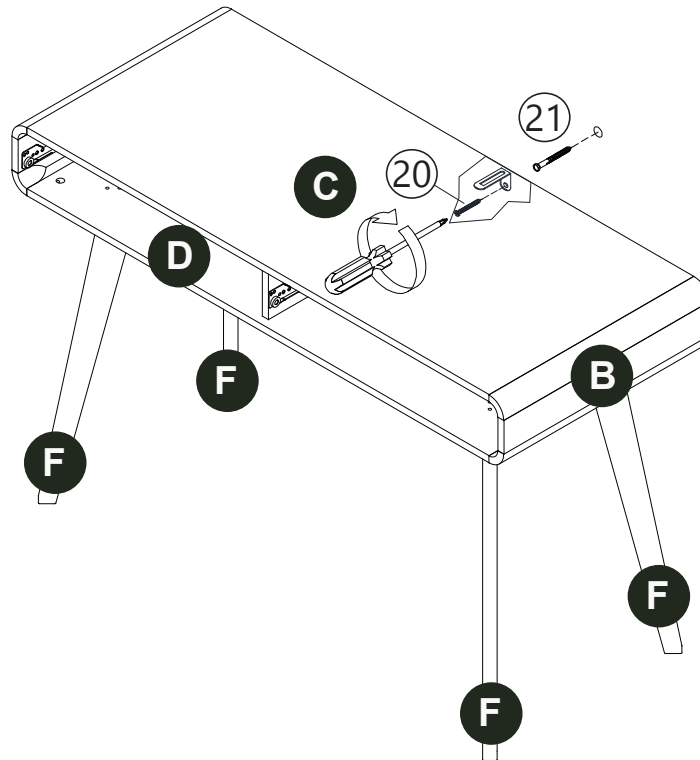
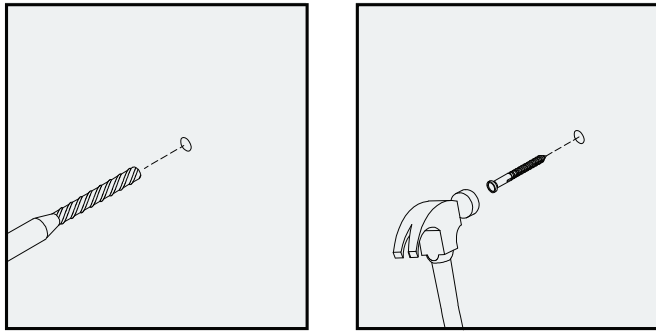

Step 22

Insert the drawer one by one and make sure the roller is on each side of the drawer slide.

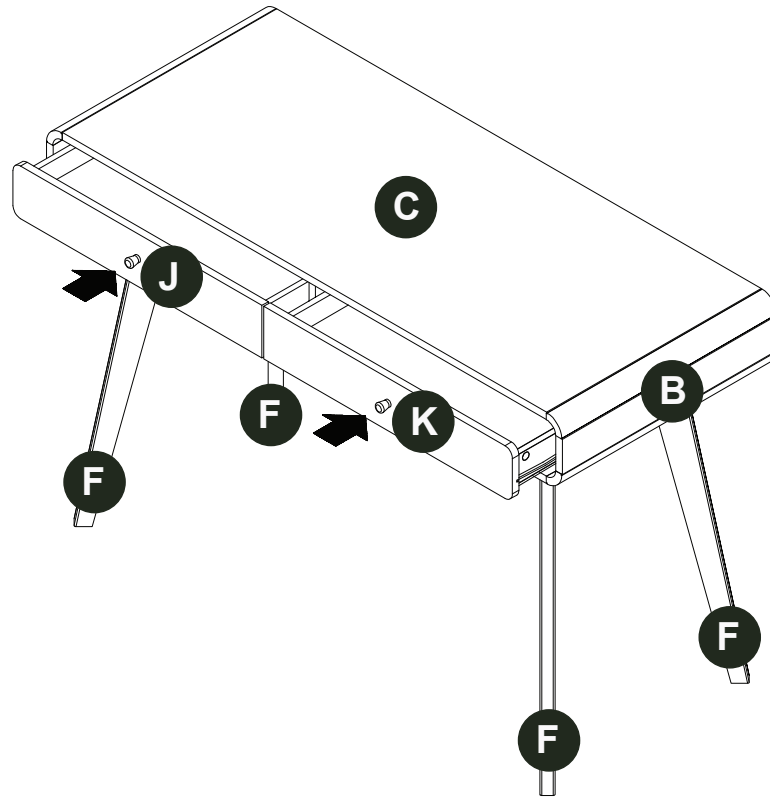

⚠ CAUTION: This unit is intended for use only with the products and/or maximum weights indicated. Use with other products and/or products heavier than the maximum weights indicated may result in instability or cause possible injury.

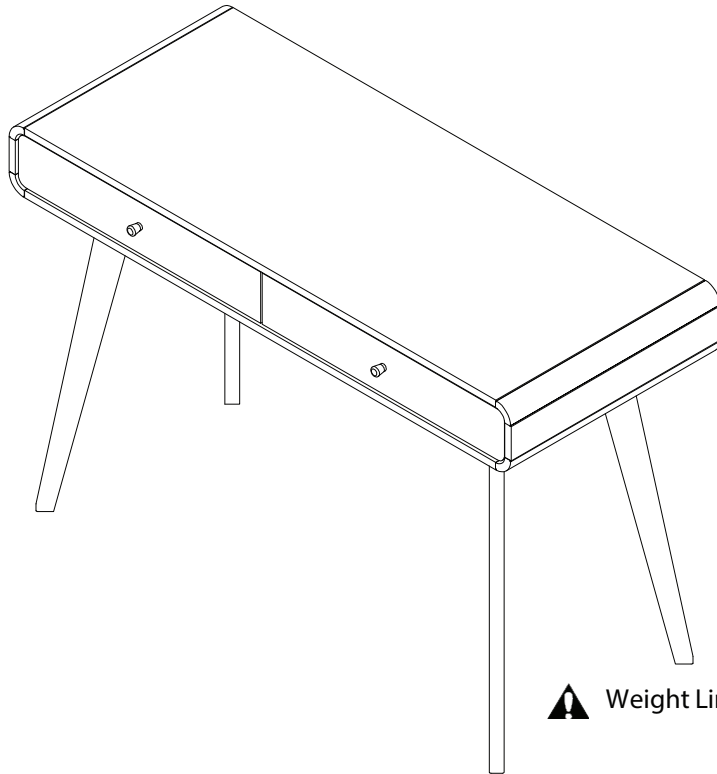

⚠ Weight Limit: 50.7lb / 23kg (Middle part)

Helpful Hints

- Move your new furniture carefully, with two people lifting and carrying the unit to its new location.
- Your furniture can be disassembled and reassembled to move.
- Clean the product with a soft damp cloth. DO NOT use harsh chemicals or abrasive cleaners.
- Check bolts and nuts periodically and tighten if necessary.

That's it ! You've finished assembling your **RH LEVA DESK!**

Partes

IMPORTANTE: La lista de números de piezas que aparece a continuación es exclusiva de su producto. Por favor, manténgalo a mano cuando solicite piezas de repuesto.

 Todo se incluye en 1/1 caja(s) grande(s)!

 Antes de deshacerse de las cajas de cartón, asegúrese de que estén vacías. También confirme que ha recibido todos los componentes necesarios para el ensamblaje al compararlos con la tabla de piezas indicadas en la sección en inglés.

NÚMERO DE PIEZAS		
ETIQUETA DE PIEZAS	DESCRIPCIÓN	3003009 (Oak/Black)
A	Panel lateral izquierdo	U5671611-A
B	Panel lateral derecho	U5671611-B
C	Panel superior	U5671611-C
D	Panel inferior	U5671611-D
E	Panel central	U5671611-E
F	Panel de pierna	U5671611-F
G	Panel de marco de pierna	U5671611-G
H	Panel lateral del marco de la pierna	U5671611-H
I	Panel central del marco de la pierna	U5671611-I
J	Frente del cajón derecho	U5671611-J
K	Frente del cajón izquierdo	U5671611-K
L	Lado del cajón izquierdo	U5671611-L
M	Lado del cajón derecho	U5671611-M
N	Parte trasera del cajón	U5671611-N
O	Soporte de cajón	U5671611-O
P	Panel inferior del cajón	U5671611-P
Q	Panel de respaldo	U5671611-Q
A1	Panel de perfil lateral	U5671611-A1
B1	Panel de perfil lateral	U5671611-B1

Paquete de componentes

3003009 (Oak/Black)



HP# : TU5671611-01

 **Nota:** Por favor apriete completamente los pernos durante el ensamblaje, apriételes en la última etapa del ensamblaje, a menos que este indicado específicamente en alguna etapa de las instrucciones.

 Los tornillo(s), perno(s) que se utilizan en cada paso se muestran en tamaño real en la esquina inferior derecha de cada página.

Instrucciones

- Paso 1** Para cada orificio con clavija (6), (7) y (8), coloque una gota de pegamento (23) y luego procese para insertar una clavija.
- Paso 2** Inserte el minifix (9) y luego apriételo con un destornillador. Luego alinee el soporte de montaje en L (19) y luego apriételo con el tornillo (22).
- Paso 3** Fije los paneles laterales del cajón L y M al respaldo del cajón N y luego apriételos con el tornillo (5).
- Paso 4** Inserte la parte inferior del cajón P entre los lados del cajón L y M y luego continúe con el soporte del cajón O.
- Paso 5** Inserte la leva (11) en cada panel y apriételo todo en consecuencia. Antes de colocar el otro panel, coloque una pequeña gota de pegamento (23) en el orificio de la clavija de madera.
- Paso 6** Coloque la corredera del cajón (14) y asegúrese de que el rodillo deslizante del cajón quede orientado hacia la parte posterior del cajón como se muestra a la izquierda y luego apriételo con el tornillo (1).
- Paso 7** Utilice el tornillo (12) y la perilla de madera (13) y luego apriételo con un destornillador.
- Paso 8** Inserte la leva (10) en cada panel y apriételo todo en consecuencia. Antes de colocar el otro panel, coloque una pequeña gota de pegamento (23) en el orificio de la clavija de madera.
- Paso 9** Coloque la corredera del cajón (14) y apriétela con el tornillo (4). Asegúrese de colocar la corredera del cajón como se muestra.
- Paso 10** Inserte la leva (10) en cada panel y apriételo todo en consecuencia. Antes de colocar el otro panel, coloque una pequeña gota de pegamento (23) en el orificio de la clavija de madera.
- Paso 11** Antes de colocar el otro panel, coloque una pequeña gota de pegamento (23) en el orificio de la clavija de madera.
- Paso 12** Fije la pata F al panel inferior D y apriete con el tornillo (5).
- Paso 13** Inserte la leva (10) en cada panel y apriételo todo en consecuencia. Antes de colocar el otro panel, coloque una pequeña gota de pegamento (23) en el orificio de la clavija de madera.
- Paso 14** Coloque el soporte de la esquina de la mesa (15) en el marco de las patas y apriete los tornillos (2) y (3) y asegúrese de colocar el tornillo de acuerdo con la pantalla de pasos.
- Paso 15** Fije los paneles centrales E y luego apriételos con el tornillo (5).

Paso 16 Inserte la capa posterior Q en la parte posterior del panel E.

Paso 17 Inserte la leva (10) en cada panel y apriételo todo en consecuencia. Antes de colocar el otro panel, coloque una pequeña gota de pegamento (23) en el orificio de la clavija de madera.

Paso 18 Inserte la leva (10) en cada panel y apriételo todo en consecuencia. Antes de colocar el otro panel, coloque una pequeña gota de pegamento (23) en el orificio de la clavija de madera.

Paso 19 Inserte la leva (10) en cada panel y apriételo todo en consecuencia. Antes de colocar el otro panel, coloque una pequeña gota de pegamento (23) en el orificio de la clavija de madera.

Paso 20 Inserte el tope de respaldo (17) como se muestra y use el tornillo (18) para apretarlo.

Paso 21 Utilice el orificio del soporte de montaje en L para marcar y luego taladre un orificio. Inserte el taco de pared (21) en el orificio y luego use un martillo, luego use el tornillo (20) para apretarlo.

Paso 22 Inserte los cajones uno por uno y asegúrese de que el rodillo esté a cada lado de la guía del cajón.

Consejos útiles

- Mueva sus muebles nuevos con cuidado, se requiere de dos personas para levantar y trasladar su producto a su nueva ubicación.
- Limpie el producto con un paño suave. NO utilice productos químicos o abrasivos de limpieza.
- Revise los tornillos y tuercas periódicamente y apriételos si es necesario.
- Algunas partes han sido pre-ensambladas en este producto. Se encuentran ilustradas en esta página y disponibles para reemplazo (sección en inglés).

 No se apoye ni aplique un peso excesivo sobre el estante de la puerta delantera.

Límite de peso: (Estante de la puerta delantera) 50.7 lbs / 23 kg

PRECAUCIÓN

- La unidad puede volcar causando lesiones graves o la muerte.
- Ancle la unidad a un montante o pared.
- **NO** permita que los niños se suban al mueble.
- Coloque los objetos pesados en los estantes o cajones inferiores.
- Lea y siga todas las instrucciones de montaje.

3003009 (Oak / Noir)

BUREAU À CAME DROIT



Des questions, des préoccupations ou des pièces manquantes? **CONTACTEZ NOTRE SERVICE À LA CLIENTÈLE AVANT DE RETOURNER LE PRODUIT AU DÉTAILLANT.**

Si des pièces sont manquantes ou endommagées, nous expédierons volontiers vos pièces de rechange gratuitement.

Visitez www.realrooms.com, appelez sans frais au **1-888-489-0077**

Date d'achat

Numéro de lot

Merci d'avoir acheté un produit Realrooms!

Informations sur la garantie

RealRooms garantit que ce produit est exempt de tout vice de matériaux et de fabrication et s'engage à remédier à un tel défaut. Cette garantie est valable un an à compter de la date d'achat initiale. Elle se limite uniquement à la réparation ou au remplacement des pièces défectueuses. La main-d'oeuvre nécessaire à l'assemblage n'est pas incluse.

Cette garantie ne s'applique pas aux produits qui ont été mal assemblés, qui ont été soumis à une utilisation abusive ou qui ont subi des modifications ou des réparations. La garantie ne couvre pas l'usure, les déchirures ou la décoloration du tissu (le cas échéant). La responsabilité pour les dommages indirects est exclue quand l'exclusion est autorisée par la loi. Cette garantie vous confère des droits spécifiques légaux. Il se peut que vous bénéficiiez de droits additionnels car ceux-ci peuvent varier selon l'État ou la province.

Pour bénéficier du service de garantie, l'acheteur doit présenter la facture originale. Les composants réparés ou remplacés sont garantis jusqu'à la fin de la période de la garantie initiale uniquement. Les composants défectueux seront réparés ou remplacés sans frais, sous réserve des conditions décrites ci-dessus. Les termes et conditions de la garantie limitée sont susceptibles d'être modifiés sans préavis.

Précautions

- Ce produit est conçu pour un usage domestique et n'est pas destiné à des fins commerciales.
- **AVERTISSEMENT CONCERNANT LES JEUNES ENFANTS:** Ce produit contient des petits composants. S'il vous plaît assurez-vous qu'ils soient gardés loin d'eux.
- Ne pas utiliser d'outils électriques pour assembler votre mobilier. Ce type d'outils risque d'endommager les pièces.



CE FEUILLET CONTIENT DES INFORMATIONS DE SÉCURITÉ **IMPORTANTES**. S'IL VOUS PLAÎT LIRE ET CONSERVER POUR RÉFÉRENCE ULTERIEURE.

Avant de commencer l'assemblage

- Si vous avez besoin d'aide, appelez notre service à la clientèle sans frais.
- Travaillez dans un endroit spacieux et près du lieu où l'unité sera utilisée, préférablement sur un tapis, ou sur un morceau de l'emballage, afin de protéger le plancher et le produit.
- **Nombre de personnes recommandées pour l'assemblage : 2** (cependant il est toujours préférable d'être assisté par une personne supplémentaire).
- **Temps estimé d'assemblage : 1:30 h.**
- Assurez-vous d'avoir bien reçu toutes les pièces. La plupart de celles-ci sont étiquetées ou estampées sur leur côté non fini.
- Lire attentivement chaque étape avant de débiter. Il est très important que chaque étape de montage soit exécutée dans le bon ordre, sinon vous risquez d'éprouver de la difficulté à assembler votre meuble.

Contactez-nous!

Besoin d'aide pour assembler, identifier des pièces, vous informer sur le produit, ou pour commander des pièces? Contactez-nous :

- cs@realrooms.com
- 1-888-489-0077

Pièces

IMPORTANT: La liste des références ci-dessous est propre à votre produit.
Veuillez l'avoir sous la main lorsque vous appelez pour des pièces de rechange.

 Tout dans 1/1 grande(s) boîte(s)!

 Avant de jeter les boîtes en carton, assurez-vous qu'elles soient vides.
Vérifiez que vous avez reçu tous les composants nécessaires à l'assemblage en les comparant avec le tableau des pièces (illustrations disponibles dans la section en anglais).

NÚMERO DE PIEZAS		
ETIQUETA DE PIEZAS	DESCRIPCIÓN	3003009 (Oak/Black)
A	Panneau latéral gauche	U5671611-A
B	Panneau latéral droit	U5671611-B
C	Panneau du haut	U5671611-C
D	Panel inferior	U5671611-D
E	Panneau du bas	U5671611-E
F	Panneau de jambe	U5671611-F
G	Panneau de cadre de jambe	U5671611-G
H	Panneau latéral du cadre de jambe	U5671611-H
I	Panneau de cadre de pied central	U5671611-I
J	Façade de tiroir droite	U5671611-J
K	Façade de tiroir gauche	U5671611-K
L	Côté tiroir gauche	U5671611-L
M	Côté droit du tiroir	U5671611-M
N	Dos du tiroir	U5671611-N
O	Support de tiroir	U5671611-O
Y	Panneau inférieur du tiroir	U5671611-P
Z	Panneau arrière	U5671611-Q
A1	Panneau de profil latéral	U5671611-A1
B1	Panneau de profil latéral	U5671611-B1

Quincaillerie

3003009 (Oak/Black)



HP# : TU5671611-01



Remarque: Sauf indication contraire dans les instructions, ne pas resserrer complètement les vis et les boulons, jusqu'à ce que l'assemblage soit terminé.



Les vis et boulons utilisés durant chaque étape sont illustrés en taille réelle au coin inférieur droit de la page.

Instructions

- Étape 1** Para cada orificio con clavija (6), (7) y (8), coloque una gota de pegamento (23) y luego procese para insertar una clavija.
- Étape 2** Inserte el minifix (9) y luego apriételo con un destornillador. Luego alinee el soporte de montaje en L (19) y luego apriételo con el tornillo (22).
- Étape 3** Fije los paneles laterales del cajón L y M al respaldo del cajón N y luego apriételos con el tornillo (5).
- Étape 4** Inserte la parte inferior del cajón P entre los lados del cajón L y M y luego continúe con el soporte del cajón O.
- Étape 5** Inserte la leva (11) en cada panel y apriételo todo en consecuencia. Antes de colocar el otro panel, coloque una pequeña gota de pegamento (23) en el orificio de la clavija de madera.
- Étape 6** Coloque la corredera del cajón (14) y asegúrese de que el rodillo deslizante del cajón quede orientado hacia la parte posterior del cajón como se muestra a la izquierda y luego apriételo con el tornillo (1).
- Étape 7** Utilice el tornillo (12) y la perilla de madera (13) y luego apriételo con un destornillador.
- Étape 8** Inserte la leva (10) en cada panel y apriételo todo en consecuencia. Antes de colocar el otro panel, coloque una pequeña gota de pegamento (23) en el orificio de la clavija de madera.
- Étape 9** Coloque la corredera del cajón (14) y apriétela con el tornillo (4). Asegúrese de colocar la corredera del cajón como se muestra.
- Étape 10** Inserte la leva (10) en cada panel y apriételo todo en consecuencia. Antes de colocar el otro panel, coloque una pequeña gota de pegamento (23) en el orificio de la clavija de madera.
- Étape 11** Antes de colocar el otro panel, coloque una pequeña gota de pegamento (23) en el orificio de la clavija de madera.
- Étape 12** Fije la pata F al panel inferior D y apriete con el tornillo (5).
- Étape 13** Inserte la leva (10) en cada panel y apriételo todo en consecuencia. Antes de colocar el otro panel, coloque una pequeña gota de pegamento (23) en el orificio de la clavija de madera.
- Étape 14** Coloque el soporte de la esquina de la mesa (15) en el marco de las patas y apriete los tornillos (2) y (3) y asegúrese de colocar el tornillo de acuerdo con la pantalla de pasos.
- Étape 15** Fije los paneles centrales E y luego apriételos con el tornillo (5).

Étape 16 Inserte la capa posterior Q en la parte posterior del panel E.

Étape 17 Inserte la leva (10) en cada panel y apriételo todo en consecuencia. Antes de colocar el otro panel, coloque una pequeña gota de pegamento (23) en el orificio de la clavija de madera.

Étape 18 Inserte la leva (10) en cada panel y apriételo todo en consecuencia. Antes de colocar el otro panel, coloque una pequeña gota de pegamento (23) en el orificio de la clavija de madera.

Étape 19 Inserte la leva (10) en cada panel y apriételo todo en consecuencia. Antes de colocar el otro panel, coloque una pequeña gota de pegamento (23) en el orificio de la clavija de madera.

Étape 20 Inserte el tope de respaldo (17) como se muestra y use el tornillo (18) para apretarlo.

Étape 21 Utilice el orificio del soporte de montaje en L para marcar y luego taladre un orificio. Inserte el taco de pared (21) en el orificio y luego use un martillo, luego use el tornillo (20) para apretarlo.

Étape 22 Inserte los cajones uno por uno y asegúrese de que el rodillo esté a cada lado de la guía del cajón.

Conseils utiles

- Déplacez votre nouveau mobilier avec soin, nous recommandons deux personnes pour soulever et transporter le mobilier vers son nouvel emplacement.
- Pour le nettoyage, utilisez un linge doux et/ou humide. N'UTILISEZ PAS de produits abrasifs ou chimiques.
- Vérifiez les vis et écrous périodiquement et resserrez-les si nécessaire.
- Certaines pièces de ce produit ont été pré-assemblées. Elles sont illustrées sur cette page (section en anglais) et elles sont disponibles pour un remplacement.

⚠ Ne vous appuyez pas sur la tablette de la porte avant et n'y mettez pas trop de poids!

Limite de poids : (étagère de la porte avant) 50.7 lbs / 23 kg

⚠ AVERTISSEMENT

- L'appareil peut basculer et provoquer des blessures graves, voire mortelles.
- Fixez l'appareil à un montant ou à un mur.
- Ne laissez PAS les enfants grimper sur l'appareil.
- Placez les objets lourds sur les étagères ou les tiroirs inférieurs.
- Lisez et suivez toutes les instructions d'assemblage.